



ATS

**Forward
Together
on ESG**

**ATS Automation
Sustainability Report 2021**

About This Report

We are pleased to present ATS' second annual sustainability report. Fiscal year 2021 was an extraordinary year for the world and ATS. We were able to meet the challenge of the global COVID-19 pandemic through teamwork, a focus on safety and a commitment to continuous improvement in meeting the needs of our employees, communities and customers.

In designing and planning this report, we continued to build on the themes of ethics and governance, people, social responsibility, and responsible manufacturing and service.

In this 2021 report, we have aligned our management approach and performance disclosures to the SASB Standard for Industrial Machinery and Goods. All details related to our global operations and financial figures are in Canadian dollars, unless otherwise specified.

We welcome your thoughts and perspectives on this report and any recommendations for the future. Please contact us at investor@atsautomation.com

Contents

About This Report	2
Who We Are	3
Message from Our CEO	4
Our Story	6
Forward with Purpose	8
Making a Positive Impact	10
Ethics and Integrity	14
People	20
Social Responsibility	30
Responsible Manufacturing and Service	34
Looking Ahead	41
SASB Index	42
Forward-Looking Statements	43





Who We Are

ATS is an industry-leading automation solutions provider to many of the world's most successful companies.

ATS uses its extensive knowledge base and global capabilities in custom automation, repeat automation, automation products and value-added services, including pre-automation and after-sales services, to address the sophisticated manufacturing automation systems and service needs of multinational customers in markets such as life sciences, food & beverage, transportation, consumer products and energy.

ATS is also increasingly helping our customers meet their sustainability goals by incorporating elements of reduced waste, energy efficiency and sustainability metrics in our design process.

ATS at-a-Glance

ATA

Stock Exchange listing

28

Facilities

\$4.2 billion

Market capitalization¹

50+

Offices

\$1.4 billion

Revenue (Fiscal 2021)

20+

Countries

5,000+

Employees worldwide

25,000+

Projects completed

¹ Market capitalization as of August 31, 2021



Message from Our CEO

I am pleased to present our second annual sustainability report. It covers fiscal year 2021, a year which started with great uncertainty for ATS and our customers as the COVID-19 pandemic spread across the globe. We met those challenges and kept our commitments to our customers and communities, thanks to the energy, imagination and dedication of our people.

Across the Company, our commitment to continually improving our ESG performance and reporting is stronger than ever. Over the year, we were able to build on our ESG foundation, with our greatest focus being on the health, safety and mental wellbeing of our employees.

Early in the pandemic, at all of our operations, we helped employees who did not need to stay on site make the transition to working effectively from home. At the same time, we supported site-essential employees by having protocols and systems in place to make their work environments as safe as possible. Over this time, our pandemic response was shaped by “Forward Together,” our playbook for workplace wellbeing. Developed by ATS, this resource was so effective that customers and suppliers asked for copies, which we were happy to share.



Our primary playbook, the ATS Business Model (ABM), also made an invaluable contribution by helping to drive innovation and operational improvements. In a year filled with unknowns, the ABM helped us surmount those challenges. When our people couldn't travel, we moved to virtual meetings and found ways to provide service and support to suppliers and customers through digital tools. When a customer needed to deliver COVID-19 rapid test kits on an exceptionally tight timeline, we were able to compress a 40-week job into 14 weeks. So, while the year and the challenges were unprecedented, ATS ran true to form, embracing innovation to meet customers' needs.

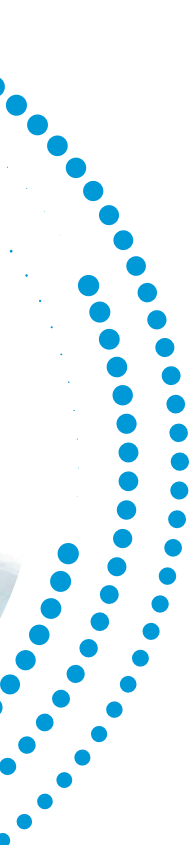

“We met the pandemic challenges and kept our commitments to our customers and communities, thanks to the energy, imagination and dedication of our people.”

We also made steady progress on our ESG Commitments. We fully embedded ESG as a Board priority and moved to develop clear lines of accountability for developing ESG policy and tracking our performance. ATS’ ESG efforts, including our reporting, continue to focus on four sustainability themes: ethics and integrity, people, social responsibility, and responsible manufacturing and service. This year’s report is structured around our performance regarding those themes and related targets we set during the year.

Additionally, the report expands on the range of topics we covered in fiscal 2020 by introducing our sustainability targets and aligning with global initiatives, including the United Nations’ Sustainable Development Goals (SDGs) and the Sustainability Accounting Standards Board (SASB) framework. These targets and reporting structures will play a vital role in helping to reach one of the most ambitious and important goals in our history: ATS is committed to becoming carbon neutral by 2030. With our people and our approach, it is a goal I am absolutely confident we will achieve.

In my letter last year, I looked forward to reporting on how society met the pandemic challenge and how ATS contributed to that achievement. The world has made tremendous progress, and as I write, COVID-19 vaccinations are still trending upward, and in our major markets, business is beginning to rebound. There is still a long way to go, but we are moving **Forward Together**. Looking to the future, our commitment to ESG will position us well to grow and succeed by achieving our purpose: Creating solutions that positively impact lives around the world.

Sincerely,



Andrew Hider
Chief Executive Officer
ATS Automation



Our Story

Established in Cambridge, Ontario, in 1978, ATS Automation Tooling Systems Inc. (TSX: ATA) is an industry-leading automation solutions provider to many of the world's most successful companies.

Our industry-leading automation and integration solutions and services streamline and optimize manufacturing operations.

A culture of innovation and continuous improvement defines our Company and our people. We are moving **Forward Together**, transforming our business by expanding into new markets, geographies and growth areas.

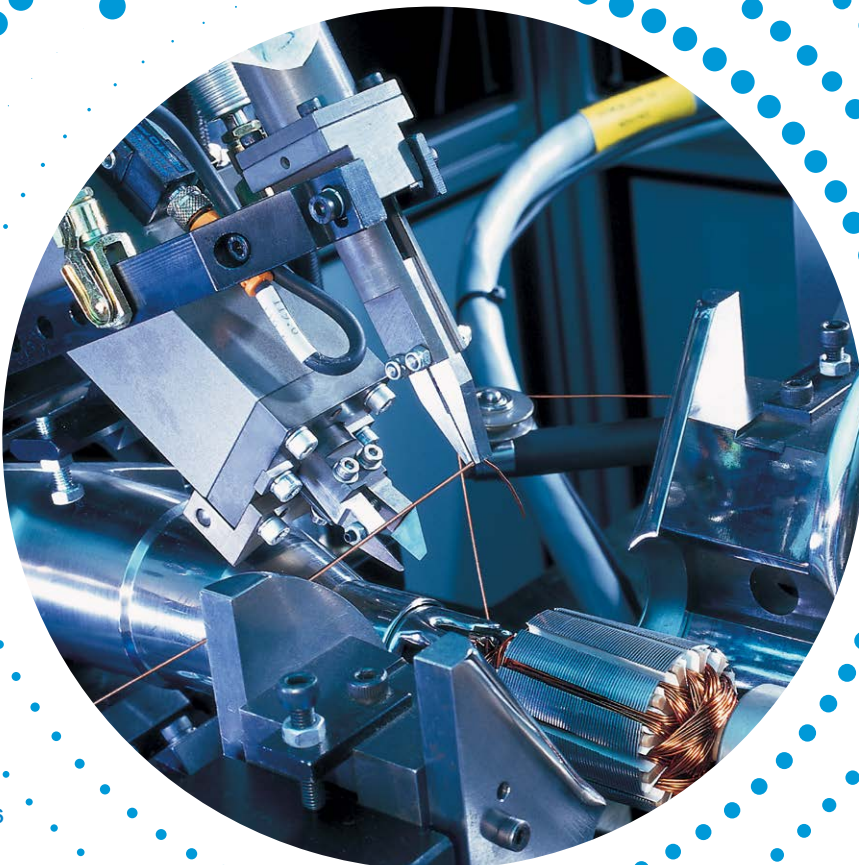

What We Do

ATS teams excel at delivering fully customized machines, systems and enterprise programs, as well as standardized products and modular capabilities, which can be scaled to meet demand.

We use our extensive knowledge base and global capabilities in custom automation, repeat automation, automation products and value-added services, including pre-automation and after-sales services, to address the sophisticated manufacturing automation systems and service needs of multinational customers.

In the **Food & Beverage** market, we serve customers in areas including fresh produce, ready-made meals, dairy and beer.

We serve **Transportation** customers in the electric and hybrid vehicle, traditional automotive and aerospace sectors.

Our **Consumer** market includes warehouse automation, personal care and cosmetics, and durable goods manufacturers.

Our **Energy** customers include energy technology companies in nuclear and solar power.

Who We Serve

Our global customers are in five key markets: life sciences, food & beverage, transportation, consumer products and energy. While diversified by region and sector, our customers all need high-precision equipment to make their products at the highest levels of quality, on time and on budget.

Our **Life Sciences** customers produce a variety of medical devices, pharmaceuticals and radiopharmaceuticals. Life sciences represents more than half of our business by revenue, up from one-third of our business a decade ago.

How We Operate

The ATS Business Model, or ABM, is our playbook. It unites our decentralized operations by providing a common language across international offices and building a common culture of excellence and continuous improvement in all areas of the business.

As ATS has grown, both organically and through acquisitions, the ABM enables us to welcome and integrate new teams at acquired companies. It helps us move forward together to deliver innovative solutions for customers and deliver value to shareholders.

- Manufacturing Facilities
- Offices

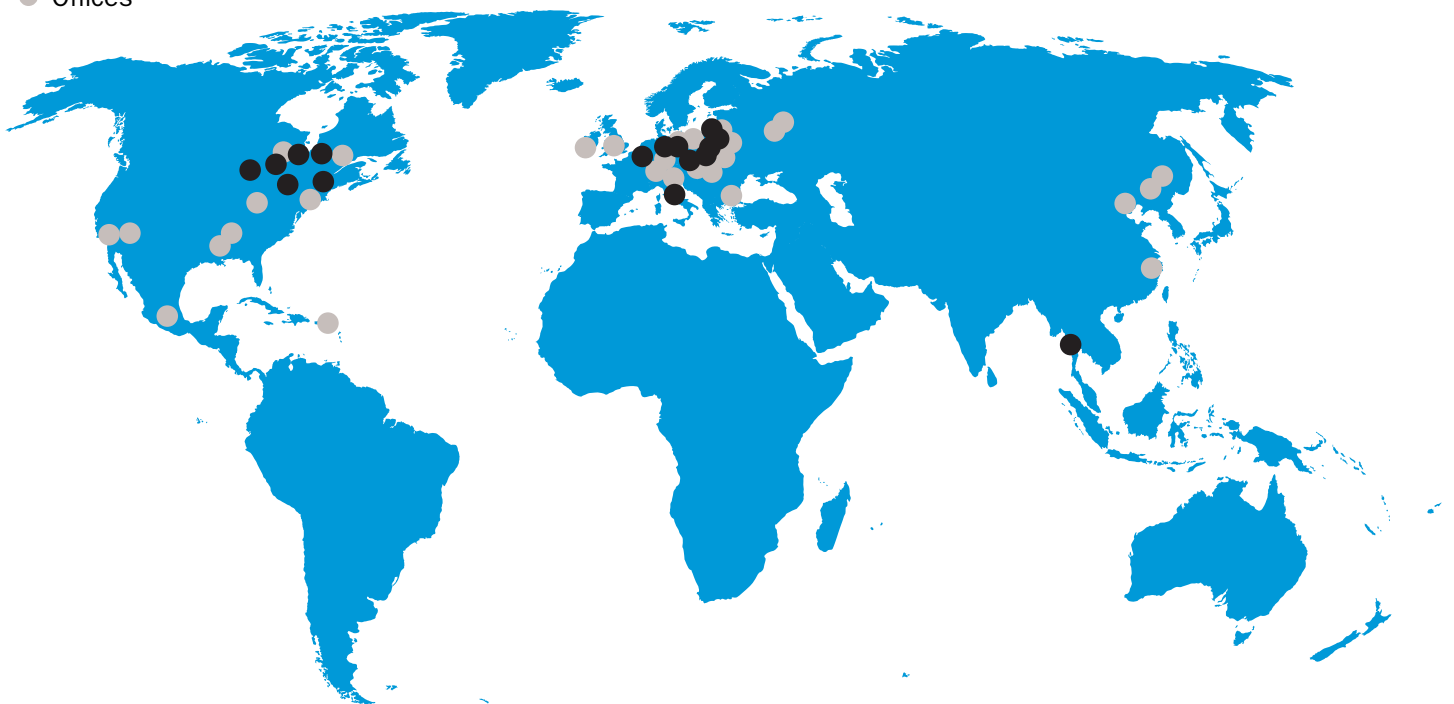

Forward with Purpose

At ATS we are inspired by our purpose, shaped by our values and guided by the ATS Business Model (ABM).

“We have an ABM mindset to improving the cost basis of running our business. In terms of the products and services we provide, the ABM mindset can inherently improve the sustainability of systems. From an ESG investment perspective, it is attractive – both as a challenge to do better, but also as a pathway in terms of further savings and cost-benefit to the business.”

Steve Emery, VP Global Procurement

Our Purpose

Creating solutions that positively impact lives around the world.

Our Values

People: Having the best team and winning as a team

- We continuously work to develop, engage, empower and energize our people
- We support our people to foster a safe, positive and inclusive work environment where everyone is respected and given the opportunity to do their best

Process: Our commitment to continuous improvement

- We align around the ABM to pursue continuous improvement in all aspects of our business
- With a balance of strategic thinking and tactical execution, we ensure that we are creating value for our customers, today and in the future

Performance: Delivering results for our customers, shareholders and employees

- We compete to win every day, always with uncompromising integrity and holding ourselves to the highest ethical standards
- We develop innovative solutions to complex problems and provide unique value that fuels growth in our markets
- We own our results and have full accountability to creating value for our customers and shareholders



Guided By the ABM

We introduced the ABM four years ago to provide management and employees at all levels of our operations around the world with a playbook for operating efficiently, scaling effectively and continually improving. As we have grown and expanded into new businesses and geographies, the ABM has made an essential contribution by giving all ATS employees a common language and shared way of looking at, and thinking about, our business. It has also shown that it can deliver results beyond operational efficiency and is now shaping our approach to strategy, sales, marketing and, increasingly, ESG targets and performance.

The ABM emphasizes a focus on performance, value drivers, KPIs and visible daily management as a foundation for pursuing excellence and contributing to customer success, through strategic planning processes, goal deployment and pioneering innovation. “Kaizen” means “change for the good”; as part of the ABM we hold Kaizen events where employees and company leaders gather together to focus on particular challenges and rapidly generate ideas and approaches for improving our performance. Adapting to pandemic-related travel restrictions, we moved to online Kaizen events and training sessions and found that despite working remotely, we were still able to foster innovation, develop solutions and drive improvements.

Making a Positive Impact

ATS makes products that make a better world. For our customers in the Life Sciences sector, we provide innovative equipment and solutions to automate the manufacturing of medical devices and pharmaceutical products that help save lives.

In the e-mobility and electric vehicle (EV) sector, we contribute to the building and testing of electric batteries that play a crucial role in moving toward a low-carbon future. Across all the sectors we serve, we are designing and building more efficient products and solutions, which help our customers achieve their sustainability commitments.

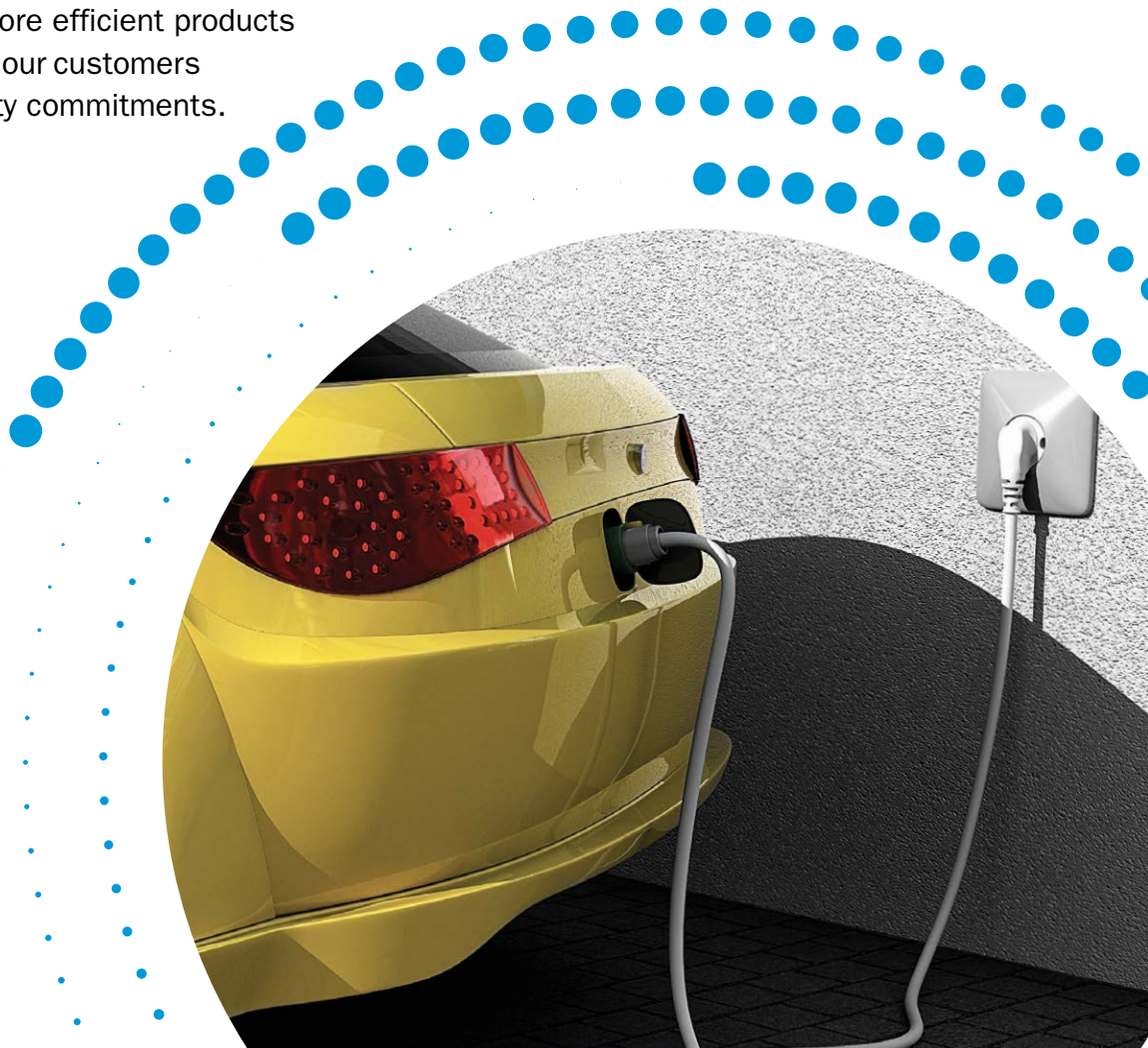

Our Long-Term Sustainability Targets

Our fiscal 2020 report identified the four themes that shape our sustainability strategy: ethics and governance, people, social responsibility, and responsible manufacturing and service. Developed using the ABM, they represent the priorities of our people and our business. In fiscal 2021, we built on that foundation by setting five sustainability targets, including becoming carbon neutral by 2030 and expanding the percentage

of women in leadership at ATS. Targets ensure accountability; we have tasked specific teams with achieving our goals. As we advance, we will provide those teams with the resources and backing they need while we expand our range of long-term sustainability targets. We see sustainability as a continuous journey that perfectly aligns with ATS’ commitment to continuous improvement.

Targets 2030

Theme	Metric	Target 2030
People Workplace Safety	Lost Time Severity Rate	4.0
People Uniqueness and Belonging	Women in leadership	30%
Ethics Employee and Manager Training	Completion of annual ethics training by all managers and employees	100%
Social Responsibility Communities Impacted	Charitable support in communities where ATS is located	100%
Responsible Manufacturing and Service Climate Change	Scope 1 and 2 emissions from operations in TCO ₂ e	Carbon neutral

“Sustainability targets stand as our public pledge to drive improvement in areas essential to the future growth, protection and prosperity of our business, and the world around us.”

Andrew Hider, CEO



Materiality Assessment

When we say the ABM guides everything we do, we mean it. In October 2019, we held a Kaizen event attended by representatives of our global Health, Safety and Environment (HSE) and Human Resources (HR) teams from all of our business segments. Supported by our ABM Champions, meeting participants determined what is material – what matters most – to ATS employees, investors, customers and other key stakeholders in order to establish our sustainability themes and initial goals.

Subsequently, we have continued to work with both internal teams and external stakeholders to sharpen our focus and further define our ESG targets. One of our objectives for fiscal 2022 is to conduct a formal materiality assessment.

Alignment to the UN Sustainable Development Goals

The United Nations' 17 Sustainable Development Goals (SDGs) are the central organizing feature of its 2030 Agenda for Sustainable Development, which was adopted by all Member States in 2015. ATS endorses this blueprint for a more sustainable future where governments, non-governmental organizations and businesses collaborate to address climate change, environmental degradation, poverty and inequality.

By virtue of our products and services and as a result of our corporate governance, leadership and strategy, ATS is playing a constructive and expanding role in a variety of areas that advance SDGs. This includes the management of our resources, operations and supply chain as well as initiatives to expand diversity and inclusion. While our efforts support a number of SDGs, we are particularly focused on SDG 3: Good Health and Well-Being, SDG 9: Industry, Innovation and Infrastructure, SDG 12: Responsible Consumption and Production and SDG 13: Climate Action.



Our automation systems and solutions are used daily by medical device and pharmaceutical customers to produce life-saving medical instruments, cancer treatments and vaccines. During the COVID-19 pandemic, our ability to deliver high-quality solutions in compressed timelines has enabled customers to quickly ramp up capacity to produce COVID-19 diagnostic tests, personal protective equipment and vaccines. By designing, building, commissioning and servicing innovative manufacturing systems and solutions, we help our customers deliver a healthier, safer world and minimize production interruptions and shortages of vital medical products. By virtue of our growth strategy, we estimate that 56% of our revenues are related to Life Sciences applications that support SDG 3.



Innovation is the lifeblood of ATS and the cornerstone of our business model. While we have solved complex production challenges by creating enabling solutions for customers on an everyday basis since our inception in 1978, we began to serialize some of our most widely used intellectual property in the form of standard products over 20 years ago. SuperTrak™ was our first such product. Over the decades, the SuperTrak™ family of smart conveyance systems has become a market leader. As a matter of strategy, we have added a variety of innovative products including Symphoni™ and Illuminate™ and, in the past three years, we have boosted investment in innovation and R&D. Our recently opened ATS Innovation Centre in Cambridge, Ontario is dedicated to accelerating the transformation of new ideas into state-of-the-art products, processes and services.



Much of the work done at ATS involves the design and then assembly of components (mostly manufactured by rigorously vetted third parties) to build state-of-the-art manufacturing lines and systems. As a result, our generation of hazardous waste is minimal, and most of the waste we generate comes from recyclable packaging. We have set targets across the Company to divert at least 80% of waste away from landfill or incineration – in fiscal 2021 we diverted 83.6%. We also track energy consumption across all ATS locations and regularly look for opportunities to increase the use of clean power and reduce consumption. Externally, ATS helps customers achieve their sustainability goals through innovative products and processes which maximize manufacturing throughput while reducing physical footprint and energy consumption. To learn more about what actions we have taken in support of SDG 12, please see “Responsible Manufacturing and Service,” [page 34](#).



ATS' offerings in e-mobility are integral to customer production of EV and hybrid vehicles. Our systems and solutions enable automotive original equipment manufacturers (OEMs) to automate battery pack assembly and testing and ensure the highest standards of quality and safety for their vehicles. ATS' innovative automation solutions for the nuclear industry span operations, maintenance, refurbishment and decommissioning, ensuring the safe and reliable use of a critical low-carbon energy source. We estimate that 20% of our revenues are related to e-mobility and nuclear solutions which support SDG 13.



Ethics and Integrity

Doing the right things the right way and putting our values into action enabled ATS to endure and succeed in a challenging year.

At ATS, people know where we stand and what we stand for, and that's important, especially in uncertain times. Our commitment to ethics and integrity, and the implementation of policies and procedures to ensure strong governance and clear accountability, made an essential contribution to our solid performance in fiscal 2021. Our full-year results were strong overall, and we continued to create value for our customers and shareholders while supporting our employees and communities.



Leadership and Accountability

We understand that clear policy frameworks and expectations around ethics, transparency and accountability are essential foundations for success. Our Board sets these expectations and provides the guidance and oversight required to ensure they are met. With the Board's leadership, we established a comprehensive range of guidelines and policies that help ensure that our employees and contractors can conduct themselves ethically and effectively, ensuring that ATS operates in a sustainable fashion that aligns with ESG principles. This is reflected in initiatives such as our commitment to becoming carbon neutral by 2030, progressing our goal of fostering uniqueness and belonging, and steadily expanding the percentage of women in management roles across our Company. In addition, because we recognize that accountability drives performance, we are committed to reporting our progress toward meeting our sustainability targets.

At the Board level, ATS has adopted sustainability leadership and executive-level commitment. This commitment extends throughout our operations, where leaders take responsibility and ownership for local projects and results.

Our governance structure for sustainability is rooted in the [Mandate for the Board of Directors](#). Through the Audit and Finance Committee, our Board maintains close oversight on our controls to ensure that the Company continues to operate ethically and in full compliance with regulatory requirements. This committee meets regularly throughout the year; any reports and investigations pertaining to ethics are reviewed no less than quarterly. Regular reports are presented to the Board in its entirety regarding our performance on workplace safety, environment, strategies to engage and develop our global employee base and progress on our sustainability targets. Both our Board of Directors and our executive leadership team recognize the importance of sustainability in the overall success of the Company in the years ahead.





Ethics and Compliance

Across all our locations, ATS operates in accordance with regional and national laws and global corporate standards. We expect all ATS employees to operate in an ethical manner and support them in this effort. Our Corporate Code of Business Conduct was developed to foster an open atmosphere that allows and encourages employees to make inquiries or to report possible business ethics violations or violations of law, regulations, policies or procedures without fear of retribution or retaliation.

In May 2021, ATS updated its [Code of Business Conduct](#) (CBC), which was adopted by the Board of Directors. The CBC supports ATS in operating with a set of core principles that guide all aspects of our work and makes clear that respect for others, ethical business dealings and compliance with laws are all fundamental tenets of our business. All ATS employees, officers and Board members are required to observe this Code as a condition of their employment. Our Code of Business Conduct applies equally to our directors, officers and employees, and serves as the guidepost for how we carry out our day-to-day business dealings. The principles of our Code continue to be reinforced by our Board of Directors, our Chief Executive Officer and our executive leadership team. Each manager at all levels of the Company is responsible for promoting awareness of, and ensuring compliance with, our Code of Business Conduct as we continue to build a great company the right way.

Our Code is reviewed and certified annually by all managers and employees and posted on our intranet in 10 different languages. To supplement the Code, ATS has adopted and published a variety of policies covering specific topics in order to provide detailed instruction and guidance across the organization. These policies are also translated into a variety of languages to suit our global operations and made available to employees via our intranet.

The Code of Business Conduct addresses expectations of conduct in a number of key areas, including:

- Employee conduct and maintaining a fair, respectful workplace;
- Recognizing and managing conflicts of interest;
- Maintaining arm's length relationships with suppliers;
- Giving and receiving gifts and entertainment;
- Investing in an ethical manner in accordance with insider trading controls;
- Working in full compliance with all laws and regulations;
- Complying with all competition and anti-trust laws;
- Maintaining full and accurate records;
- Protecting and appropriate use of corporate assets and opportunities;
- Protecting confidential information of ATS and our customers, suppliers and business partners;
- Working in a manner which protects the safety of people and the environment; and
- Reporting violations of the Code and illegal or unethical behaviour without fear of reprisal.



ATS Business Conduct Policies

- Anti-Bribery and Anti-Corruption Policy
- Anti-Trust Compliance Policy
- Code of Business Conduct
- Company Electronic Data Policy
- Conflict Minerals Policy
- Data and Records Retention Policy
- Data Breach Notification Policy
- Disclosure Policy
- Ethics Policy
- Export Compliance Policy
- Global Employee Privacy Policy
- Global Supplier Development and Evaluation Procedure
- Handling Confidential Information Policy
- Harassment Policy
- Health, Safety and Environment (HSE) Policy
- Information Security Policy
- Insider Trading Policy
- Supply Chain Policy
- Workplace Violence Policy

Where a violation of our Code of Business Conduct, policies and/or regulations is suspected, employees are encouraged and required to report their concerns to a member of the management team or our Chief Ethics Officer. In the event that an employee is uncomfortable about communicating their concern in person, ATS maintains an independent third-party hotline which is available around-the-clock, 365 days of the year via www.reportit.net or by calling 1-877-778-5463.

This contact information is provided to all employees via our employee intranet and by postings throughout our facilities globally.

In fiscal 2021 our CEO and executive leadership team confirmed our goal of ensuring that “100% of managers and employees complete required training on ethical business practices and complete a Certification to the Code of Business Conduct.” We are pleased to confirm that in fiscal 2021 this target was achieved.

Targets 2030

Ethics and Integrity	Target 2030	Fiscal 2021	Fiscal 2020
All managers complete required training on ethical business practices and complete Certification to the Code of Business Conduct.	100%	100%	100%
All employees complete required training on ethical business practices and complete Certification to the Code of Business Conduct.	100%	100%	100%

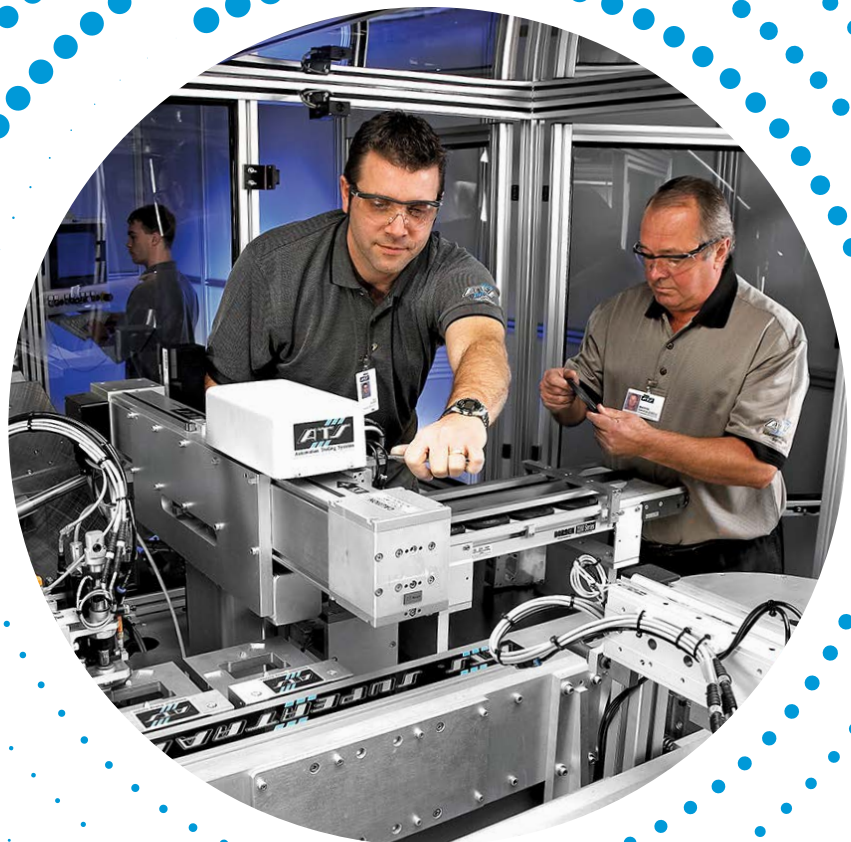

Working with Suppliers

The ATS Supply Chain team focuses on several elements that we believe are critical to maintaining a robust and reliable supply chain for the organization globally. Key performance indicators for supplier performance have been standardized across the organization and are monitored regularly. Processes and standards for selecting and monitoring suppliers are established, with training provided globally to our local supply chain teams. Our supply chain teams work in partnership with our quality assurance teams to monitor risk, evaluate performance and work with our supply chain partners on continuous improvement initiatives. ATS works with a global supplier base that it audits regularly to ensure compliance with our agreements and expectations. ATS requires its suppliers to operate according to our [Supplier Code of Ethics](#), which clearly lays out our expectation that suppliers conduct their activities ethically and comply with all applicable laws.

All new suppliers are required to complete our Global Supplier Development and Evaluation process. This process is designed to ensure that our suppliers can meet ATS supply expectations and mitigate risk to our business by working only with legitimate suppliers who understand and observe their regulatory obligations. Suppliers are required to sign our Non-Disclosure Agreement, complete our Supplier Profile documentation, submit acceptable Proof of Existence and pass a World Check verification. Our New Supplier Self-Assessment requires potential new suppliers to comment on their compliance with applicable health, safety and environmental regulations, equitable labour practices and improvement of workplace standards and conditions. Additionally, information with respect to compliance with employment law for the potential supplier and their suppliers is required. All suppliers are also required to acknowledge and abide by the requirements of our Supplier Code of Ethics. To maintain high visibility on these compliance issues, all suppliers must complete this screening and certification process every three years.

Suppliers who will be performing work onsite at one of our global facilities or providing onsite support at a customer location are also subject to our Contractor Management HSE Standard. This Standard applies to all ATS locations globally and is made available to all employees via our intranet. The Standard details applicable requirements for ensuring proper Workers' Compensation insurance coverage; validation of health, safety and environmental training suitable to the risks of the work; communication of safe work procedures and policies; and completion of necessary safety orientations before beginning work.

When onboarding new supply chain partners, we work with them to ensure they understand our expectations and require that they sign on to our Supplier Code of Ethics. If a supplier does not comply or is found to have acted unethically, we will no longer work with them. Over the past five years, three suppliers have been disqualified due to conflict with our Supplier Code of Ethics. In fiscal 2021, there were no suppliers disqualified due to ethical concerns.

Materials Sourcing

The SASB Industrial Machinery & Goods Standard identifies critical materials as defined by the U.S. National Research Council of which cobalt, magnesium, tantalum and tungsten are most relevant to subcomponents associated with our products. We do not purchase such materials in their raw form, however they may be present in components and sub-assemblies that we purchase for integration into our products. Our key purchased materials include steel and aluminum, and key purchased components include electronics, molded parts, custom tooling, weldments and wiring components.

We address and control risks associated with critical materials in a variety of ways, including diversification of suppliers, supply forecasting and designing our automation solutions to minimize the use of limited or scarce resources where customer specifications permit.

ATS operates in compliance with our Conflict Minerals Policy which sets forth our requirements for supplier due diligence, risk assessment exposure and compliance.

People

Protect our people and their families. More so than ever, that was our priority in an unprecedented year. We focused on staying close to our employees and our teams: helping them manage the challenges – mental, emotional, physical and operational – that came with the pandemic.

In all of our interactions, we were guided by the values and behaviours that define our culture: Workplace Health and Safety, Health and Wellbeing, Employee Engagement and Development, and Uniqueness and Belonging. Throughout the year, the resilience of our people shone through. By staying connected to our people and supporting engagement, we helped employees lay a foundation for performance, growth and achievement of our 2030 goals.



Workplace Health and Safety

ATS believes there is nothing more important than the health and safety of its people. So, ensuring that our employees are safe at work – wherever they are working from – has always been a priority. Our approach helped us meet the pandemic challenge; while we had to adapt and innovate, in many ways, we were doing what we've always done.

ATS is uncompromising in its commitment to provide a sustainable, safe and healthy work environment and we continually work to eliminate hazards that could result in personal injury or harm to the natural environment.

Management System Approach

Oversight of health and safety rests with our Board, who monitors strategy and performance through regular reporting. Our strategy is further shaped through the guidance and oversight of our HSE Steering Committee, which is chaired by our Corporate Director of Health, Safety and Environment. Comprised of senior operational leaders from across the organization, the Steering Committee meets on a monthly basis to provide insight and direction on eliminating workplace injuries and minimizing our environmental impact. In fiscal 2021 this committee was instrumental in providing ongoing guidance and feedback on our strategies to respond to the pandemic as well as assisting us in charting new ground as we seek to expand our impact on the health and wellbeing of our employees.

Across ATS, our Global Health, Safety and Environmental Management System aligns our approach to identifying, assessing and controlling occupational safety and environmental risks, including critical areas such as incident investigation, HSE training, emergency preparedness, control of hazardous energy, ergonomics and waste management. ATS requirements for safe work are extended to our contractors; our Contractor Management Standard details requirements for selection and qualification of contractors for labour and service, including review of trades qualifications, safety training and orientation, and pre-start HSE meetings.

Our commitment to eliminating injuries and protecting the natural environment is further supported by our HSE Audit process, which encompasses all operations globally. Our audit system incorporates not only our internal standards but also includes international standards, including Canadian Standards Association (CSA), American National Standards Institute (ANSI), Conformité Européenne (CE) as well as country-specific requirements. We audit our operations at least every three years, in addition to regular site visits and inspections. All audit and inspection findings are documented in a detailed report that includes recommendations shared with the local management team to implement corrective action. In fiscal 2021 we pivoted our audit processes to a remote model due to global travel restrictions, where compliance with system requirements was reviewed and assessed through document audits and video conferences.

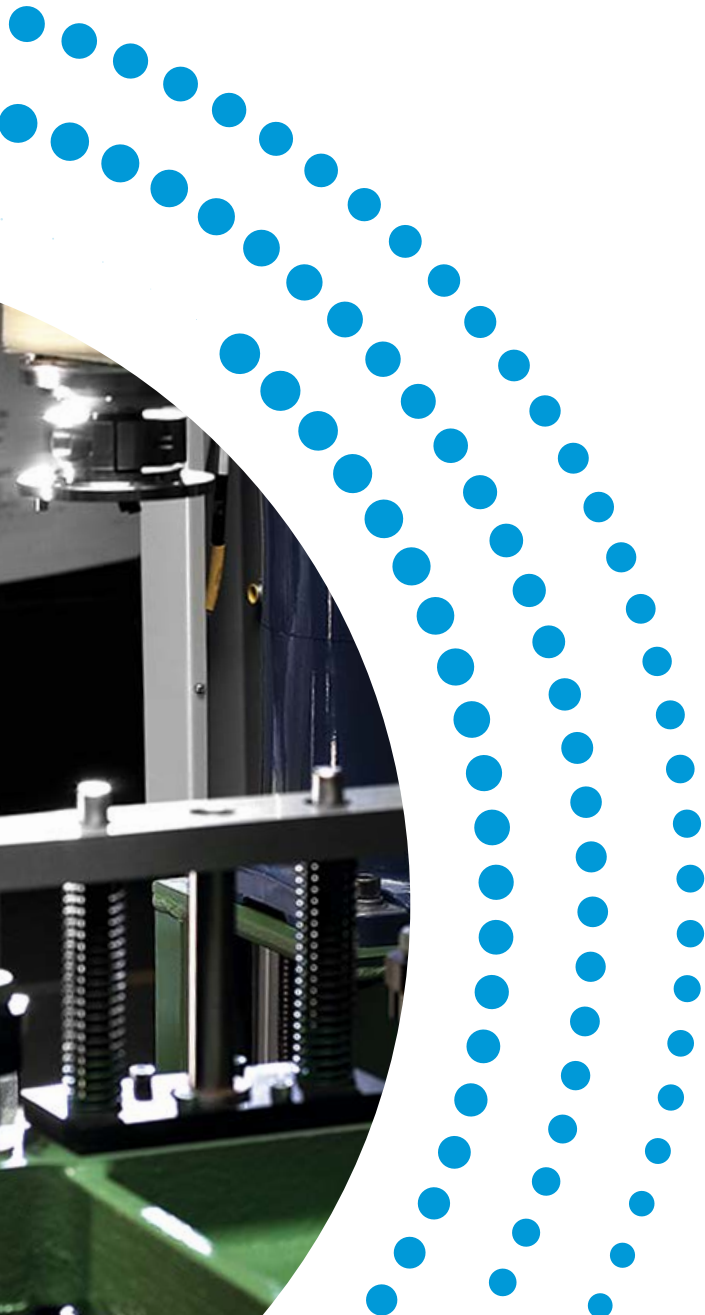

Workplace Health and Safety Performance

Key Performance Indicator	Fiscal 2021	Fiscal 2020	Fiscal 2019
Compensable Injury Frequency Rate ¹	1.07	1.20	1.21
Lost Time Severity Rate ²	9.84	8.18	10.20
Total Recordable Injury Frequency Rate ³	4.38	5.98	6.09

In fiscal 2021 we continued to improve our injury performance rate. Building on the success of our safety observations initiative introduced in fiscal 2020, we continued to drive early recognition of hazards and peer-to-peer engagement. Although a portion of our trained observers were dispatched to work remotely, we continued to empower our workforce to identify and report unsafe conditions and actions. In fiscal 2021 we saw over 40 reports of potential hazards identified and resolved as a result of employee reporting in addition to the peer-to-peer coaching provided by our safety observers.

At ATS we encourage the reporting of all near-miss incidents. Near-miss incidents are subject to the same incident investigation process as incidents which result in personal injury or property damage. We define a near-miss incident as an undesired event which, under slightly different circumstances, could have resulted in an injury, damage to property, fire, environmental release or other loss.

Local investigation teams work together to identify immediate and root causes that contributed to the near miss and identify short-term containment and longer-term permanent corrective actions to prevent a recurrence. In fiscal 2021 we received 35 reports of near-miss incidents, all of which were recorded, investigated and subjected to corrective action. Our Near-Miss Incident Rate is calculated as total number of near-miss events x 200,000/total working hours.

As we continue to improve our systems and performance, we are pleased to announce an important target in our commitment to reduce workplace injury. Our executive leadership team has set a target for the reduction of days lost associated with workplace injury. By fiscal 2030, we intend to reduce our Lost Time Severity Rate from our current rate of 9.84 to 4.0. Reducing our lost time days by more than 50% to meet our target will take focus, but we believe it is achievable by sharing best practices, engaging our global workforce and leveraging our ABM. We look forward to reporting our strategies and progress to this goal in the future.

Targets 2030

People	Target 2030	Fiscal 2021	Fiscal 2020
Lost Time Severity Rate ²	4.0	9.84	8.18

¹ Compensable Injury Frequency Rate calculated as total number of injuries compensable under Worker's Compensation statutes x 200,000/total number of hours worked

² Lost Time Severity Rate calculated as total number of days lost due to work-related injury x 200,000/total number of hours worked

³ Total Recordable Injury Frequency Rate calculated as total number of injuries defined as OSHA recordable x 1,000,000/total number of hours worked

Significant milestones in safety performance were celebrated by three of our locations in fiscal 2021. PA Solutions Inc., located in South Carolina, USA, and Process Automation Solutions Inc., located

in Alabama, USA, both celebrated 1,000 incident-free days, while ATS Life Sciences Chicago, located in Illinois, USA, achieved five years without a lost time injury.

In fiscal 2020 we shared the development of our hand safety assessment tool after a successful pilot and it has continued to deliver results. Analysis of all hand injuries has shown a 40% decrease from fiscal 2019 to fiscal 2021. We are encouraged by this reduction and remain committed to continuing to find new methods to eliminate these injuries.

With the change to remote work arrangements impacting a significant component of our workforce, we developed and launched an Ergonomic Self-Assessment tool. This tool allowed our employees to assess their home workstations and identify necessary adjustments and peripherals to continue to work comfortably throughout the pandemic.

Empowering all employees to work safely through awareness and training is a key element of our safety culture model which was introduced last year. Significant effort has gone into preparing an online HSE training management system which we expect to launch in fiscal

2022 and that is integrated with our Human Resources Information System. Utilizing this system, we will gain significant ability to monitor training compliance and plan all required safety and environmental training across the organization, with training needs defined by job scope and role.

In fiscal 2021 we utilized the Employee Engagement Survey to ask our employees to share their thoughts and opinions about the health and safety program at ATS. We were pleased to see that the responses to the statement “My supervisor is serious about protecting my health and safety” once again netted the highest overall score to any question on the fiscal 2020 Employee Engagement Survey.

We expanded our survey questions this year to gain more insight into how our safety culture is evolving; while the results are encouraging, we also see opportunities to improve in the years ahead.

Employee Engagement Safety Question	Fiscal 2021	Fiscal 2020	Fiscal 2019
My supervisor is serious about protecting my health and safety.	90%	91%	91%





Health and Wellbeing

Safeguarding the health of our employees by preventing infection was a clear priority in fiscal 2021. Unavoidably, this meant we had to pause many of our onsite wellness activities to respect physical distancing and group size limitations.

At the same time, we saw how important it was to provide education and opportunities for our employees to improve their physical and mental health. Consequently, we formed the Health and Wellbeing Committee (HWC). The team, comprised of Human Resources and Health, Safety & Environment leaders from various regions and business units, was tasked with defining a strategy to advance the wellbeing of our global employee base.

Throughout fiscal 2021, the HWC met regularly to research and discuss emerging trends, understand needs, assess online tools for personal wellness and, most importantly, build on the successes of our current activities around Health and Wellbeing. Critically, the Committee led a series of focus groups with employees based in different countries and different business units. The goal was to learn what employees felt were our best program offerings, where they saw opportunities for improvement and what they viewed as the most relevant factors for improving their health and wellbeing in the future. We look forward to launching the results of this project in fiscal 2022.

Navigating Through the Pandemic

When COVID-19 was declared a pandemic in March 2020, ATS was prepared. We had begun planning early in the year, as our Board and management team recognized the potential implications of this unprecedented challenge. One of our first initiatives was to implement a Pandemic Response Team (PRT) made up of a cross-section of leaders from the various business units and geographies that included representatives from IT, legal, supply chain, operations and human resources. The multi-jurisdictional team continues to meet weekly to review safety and work protocols, analyze risks and opportunities, and evaluate performance. From day one, the PRT's first priority was, and remains, employee safety.

Our PRT developed and launched our pandemic playbook, *Forward Together*, as a guide for our managers and employees in adjusting our workplaces and work habits to our new shared reality. We initiated work from home policies at the beginning of the pandemic to lower employee densities across our facilities and provided tools for managers and employees to ensure that communication and connection remained high while employees worked remotely. For those who had to be physically present at our facilities, we focused on enabling productivity while maintaining physical distance. Across our organization, we launched new protocols for staggered start and stop times, daily employee self-screening for onsite work, personal protective equipment, reduced capacities in common working areas, enhanced surface cleaning protocols and directional traffic flow markings within our facilities to reduce contact potential. We introduced personal sensing devices to provide proximity alerts to team members at a number of facilities where ensuring safe social distancing posed a challenge due to the dynamic nature of essential tasks. Virtual meetings for internal and external audiences were adopted and we devised creative ways to continue to support our customers, despite travel restrictions and closed borders.

The perspective and insights of our employees help us plan our strategy and evaluate our performance. Late in fiscal 2021, we included a series of COVID-19-focused questions in our Employee Engagement Survey to gain further insight into how we were responding to the challenges of the pandemic. The results were informative and encouraging. Across the board,

employees felt that safety is a priority for the Company; they also believed that ATS is responding effectively to protect team members from COVID-19. These results aligned with an earlier spring 2020 survey, showing that our approach to the pandemic has been consistent and effective. In another encouraging finding, managers acknowledged the value of the *Forward Together* playbook as a resource.

Much of our success in navigating the pandemic can be traced to the ABM and to our rapid implementation of protocols and policies designed to keep our people safe. When the pandemic struck, we already had a flexible, innovative, responsive and results-oriented culture in place. The challenges were new, but our approach was proven. Our actions were guided by the insight of our global HSE Policy: "there is nothing that we will do today that is more important than protecting the health and safety of our employees." We're proud of the cooperation and commitment demonstrated by our employees to protect each other, our families and our communities during the pandemic. As the pandemic recedes, the lessons learned over the last year will prepare us well for future challenges. Forward together.

“Our people continue to be passionately engaged in delivering our purpose. I am so impressed with the innovative and resourceful ways we have continued to service customers around the world. In many respects we are emerging as a stronger team and a stronger company.”

Angella Alexander, Chief Human Resources Officer

Employee Engagement and Development

We believe that understanding how our employees feel about their jobs, their managers, their futures and about ATS as an organization is an essential measure of our organizational health. We also recognize that our Company benefits from investing in employees and helping them to develop their capabilities and reach their potential. While we monitored engagement and worked to strengthen our connections with employees as they dealt with the pandemic, it is important to understand that we would have taken a similar course in an ordinary year. Engagement is fundamental to our approach and is a critical source for insights that we can use to enhance our competitiveness by ensuring that ATS is an employer of choice for talented, motivated people.

As part of our overall employee engagement strategy, ATS conducts regular employee surveys. In January 2021, we completed an Employee Engagement Survey, provided in 10 languages, that went out to 40 divisions across Canada, the USA, Europe and Asia. While participation in the survey is not mandatory, we had a strong overall participation rate of 75.3%, representing 3,128 employees.

The robust participation rate indicates that our workforce is engaged and that they believe their voice matters to our leadership team. No workplace is perfect and there is always room for improvement, but overall responses to the survey were positive. Employees are generally proud to be part of ATS and the work we do, they enjoy good relationships with their teammates and like their managers, and over 1,400 respondents made favourable comments about the collegial and positive atmosphere at ATS.



Survey Participation Rate

75.3%

Total # of Respondents

3,128

34% Under 35 years of age

43% 3 years or less at ATS

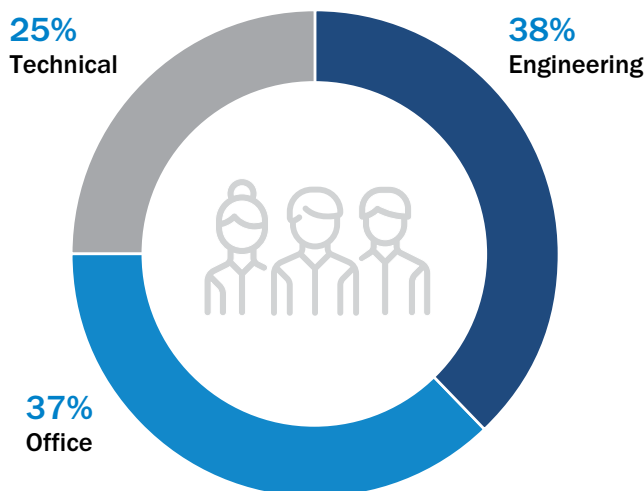
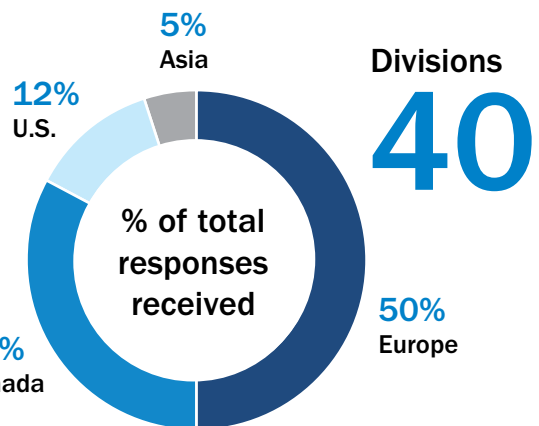

Regional Participation Rate

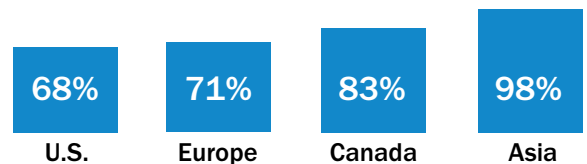

Languages

10

- Chinese
- Czech
- Dutch
- English
- French
- German
- Italian
- Slovenčina
- Spanish
- Thai

The survey also helps leadership understand varying employee priorities aligned with region, division and demographics. For example, one region places a high priority on “work-life balance” while another is more focused on “job security.” Certain employee groups prioritize “flexibility” while others value “certainty.” The insights gained into these different priorities help us to continually refine our management approach and growth strategy to further ensure that ATS attracts and retains the best talent in our industry.

One of the most encouraging findings of the survey, which ties in directly to employee development and retention, is how favourably ATS employees rate their managers. All survey questions about managers showed at least a 75% approval rating. It was also satisfying to note that since 2012, employees feel that management coaching behaviour has steadily improved. This has been a focus for the Company, and we are pleased with this result, though we remain committed to doing better.

During the pandemic, mental health and wellbeing emerged as an important issue for employees and ATS. To help support our employees in this period of challenge and disruption, we helped make mental health resources available, and team leaders conducted regular virtual check-ins with staff to see how they were coping and how we could help. In addition, our recently created HWC oversees this issue and works to ensure that employee mental wellbeing is an essential element of our overall HSE program.

Along with safety, building from within is also a priority for ATS and an important part of our continuous improvement culture. ATS is invested in helping our people, particularly future leaders, develop their skills and realize their potential. We are working to implement standardized approaches for both manager training and a total rewards program. In a decentralized, global company like ATS, we always need to be conscious of different expectations and circumstances across divisions and regions.

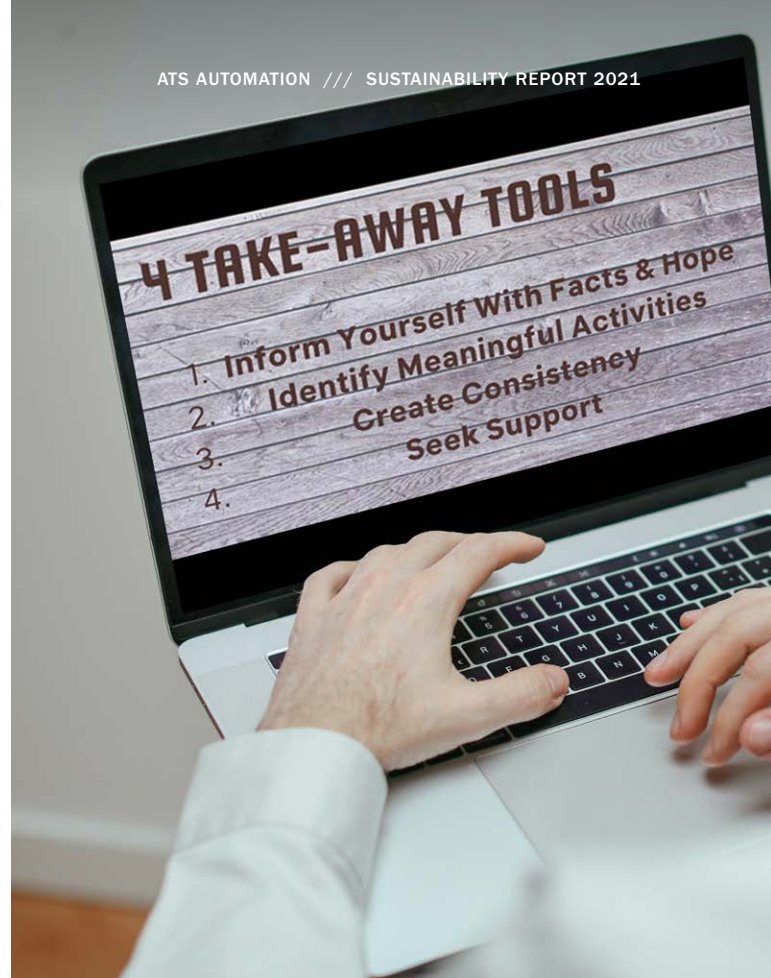

Parenting Through the Pandemic

A part of our larger efforts to support employees’ mental health and wellbeing, in fiscal 2021 we launched our second Business Resource Group, the ATS Parents’ Network, a forum for employees to join an informal peer discussion group on a range of topics related to the experiences and concerns of parenting. These ‘Coffee and Crayons’ sessions have become a popular peer-network community for discussing and sharing views. Recognizing the unique challenges of raising children in a climate of social distancing and online learning, the Parents’ Network programmed a session around managing uncertainty and anxiety. We are proud to support this new network and look forward to its growth and expansion.

Uniqueness and Belonging

At ATS, we understand that innovation doesn't come from sameness. We recognize that being a decentralized, multinational, multicultural company is one of our greatest strengths. That's why we've made embedding uniqueness and belonging into our culture one of the core components of our People strategy. ATS is committed to building a work environment where people can be themselves and be their best.

A key priority for our executive team and Board is to significantly increase the percentage of women in leadership roles. In fiscal 2021, we set a target of 30% women in leadership roles by 2030. To help launch a new generation of leaders, we are focusing on those development programs and support structures that will enable women currently working at ATS to prepare for – and succeed in – making the transition to leadership positions.

Building on the success of our first internal Business Resource Group (BRG), the ATS Professional Women's Network (PWN) of Canada, and drawing on experience gained during the pandemic, we helped create the ATS

Parents' Network (APN). The APN supports parents in sharing information, resources and practical advice for meeting family obligations and building their careers.

The PWN launched a mentorship program in 2021, aimed at fostering an environment that develops individuals and future leaders. Additionally, we are also exploring ways to encourage and support women in pursuing education in STEM-related disciplines, including 'Women in Nuclear' scholarship programs.

Uniqueness and belonging foster innovation. Our initial focus on gender does not define or limit our commitment to creating a culture where people are welcomed and valued for the unique and varied backgrounds and perspectives that they bring to ATS. Their talent and dedication will drive our success.

Targets 2030

People	Target 2030	Fiscal 2021	Fiscal 2020
Women in leadership	30%	12.5%	12.6%

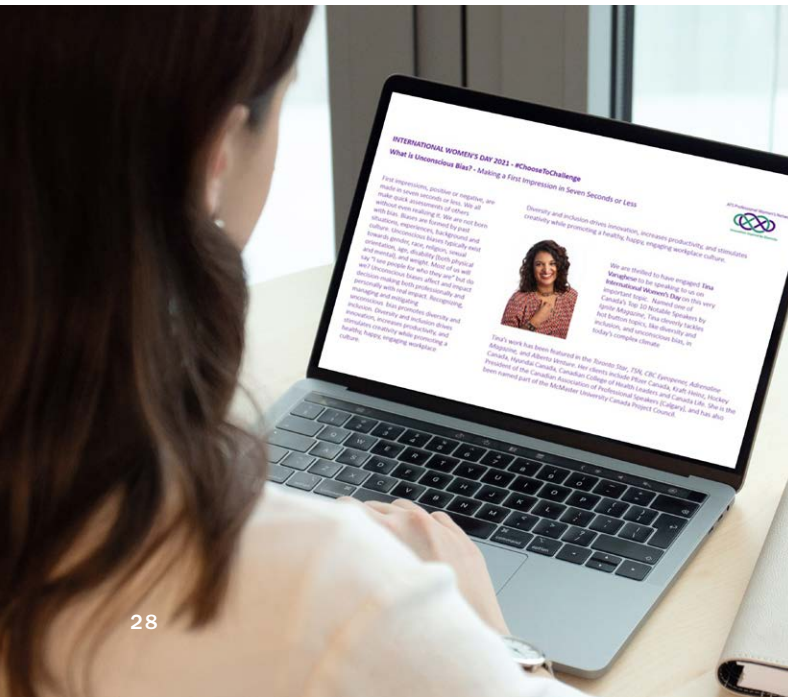



Women at ATS Fostering Uniqueness and Belonging

In fiscal 2021, our Professional Women's Network of Canada continued to provide a forum for discussion and mentorship among our Canadian employees. This included celebrating International Women's Day with a session dedicated to recognizing unconscious bias, perceptions about groups of people that individuals can hold outside their conscious awareness. Overcoming unconscious bias is crucial to creating an environment that supports uniqueness and belonging. The PWN also hosted a virtual learning series centred around staying mentally well during challenging times with discussion topics that included Maintaining Good Mental Health Through Self-Care and Managing Stress.

Guided By Our Values, Shaping Our Behaviours

Our values, centred around People, Process and Performance, are deeply embedded in our culture. However, the ways in which we incorporate those values into our day-to-day activities and operations, our

behaviours, are continually evolving and improving. In fiscal 2021, we showed the power of our values in action. Moving forward, they will continue to play a vital role in ensuring that we come out of the pandemic as a stronger company – more united, more committed to each other, our communities and our customers, and better able to realize the opportunities of the future.

 People Having the best team and winning as a team	 Process Our commitment to continuous improvement	 Performance Delivering results for our customers, shareholders and employees
Support Each Other <ul style="list-style-type: none"> • Foster inclusive collaboration • Create an environment of safety and wellbeing • Work cross-functionally and cross-organizationally 	Continuous Improvement Mindset <ul style="list-style-type: none"> • Focus on process discipline • Be data and metric driven • Use ABM toolkit to improve value drivers 	Winning with Integrity <ul style="list-style-type: none"> • Act ethically and be compliant • Compete to win • Outpace the competition • Show intensity every day
Develop People and Team <ul style="list-style-type: none"> • Foster learning and development to help people take on new challenges • Take the time to listen, coach and mentor • Be open and transparent with feedback and communication • Build organizational capability and talent 	Drive Customer Value <ul style="list-style-type: none"> • Understand customer needs • Deliver benefits and eliminate waste • Drive value in a way that is sustainable for all stakeholders 	Fuel Innovation <ul style="list-style-type: none"> • Take risks and learn through experimentation • Drive technological leadership • Leverage competitive advantages to create new markets
Model Positive Attitude <ul style="list-style-type: none"> • Inspire a “can-do” spirit in others • Be firm on the issue but fair on the person • Have respect for one another 	Balance Strategic Thinking and Tactical Execution <ul style="list-style-type: none"> • Show ability to get hands on • Balance the near term and long term in all decisions • Focus on the future • Adapt your approach to the situation 	Relentless Ownership of Results <ul style="list-style-type: none"> • Embrace stretch • Create a “no excuses” environment • Refuse to accept defeat • Demonstrate responsibility and accountability

12.5%
 Gender diversity of management (female)

15.8%
 Gender diversity of employee population (female)

At ATS, we recognize that innovation doesn't come from sameness. Being a decentralized, multinational, multicultural company is one of our greatest strengths.

4/5
 Employee engagement score (2021)

5.1%
 Voluntary turnover



Social Responsibility

Everywhere we operate, we're part of the community with an obligation to do our best to have a positive impact. Working with our neighbours, we leverage our focus on continuous improvement, and our desire to make tomorrow better than today.

ATS works to contribute to sustainable communities, create an environment where diversity and inclusion are valued, and be recognized as a good neighbour and corporate citizen. In previous years, we have connected with our communities as our people supported and participated in local events and initiatives. However, fiscal 2021 was like no other. For ATS, our most important priority was keeping people and communities safe. So, while we continued to provide financial and other supports to community-based programs, we did not take part in face-to-face events. We know this was the right decision, and as the pandemic recedes, we are even more eager to be part of our communities and expand our charitable activities and support to include every community where ATS operates by 2030.



Connecting with Our Communities

Recognizing the challenges posed around the world by restrictions and closures in industries such as retail and service, we realized the financial impact that the pandemic would have on many families. Therefore, to support affected families, we decided to focus most of our charitable giving on addressing food insecurity in the communities where we operate. Globally, we donated over \$200,000 to community food banks in fiscal 2021.

Additionally, as part of our efforts to support our communities, we looked for opportunities to contribute to charities assisting those with developmental and medical needs. Over the year, we were pleased to make donations to an international group of charities, including KidsAbility, the Ride to Conquer Cancer, Radio 7 Dragon Children, the Cancer Center @ University Hospital Tübingen, Lugo Hospital and Ageop Ricerca –

Associazione Genitori Ematologia Oncologia Pediatrica. In alignment with our green energy and carbon offsetting initiatives, we also made a financial contribution to atmosfair.

Contributing to Community-based Organizations

ATS connects with communities in many ways. Our employees volunteer their time and energy and at an individual site level, we support local charities and initiatives through financial contributions and other forms of donations. In fiscal 2021, we expanded our commitment to positively impact the communities where we live and work. We're pleased to confirm our target for increasing our engagement with our communities:

Targets 2030

Social Responsibility	Target 2030	Fiscal 2021	Fiscal 2020
Positively impact every community where ATS operates through participation in charitable giving and community support events.	100%	15%	9%



At ATS, we know how important it is to help local schools, colleges and universities encourage students to pursue STEM disciplines. Consequently, in fiscal 2021, we donated to the Waterloo region's FIRST® Robotics competition for students and Conestoga's Jill of All Trades initiative to help young people explore opportunities in technology.

In total, ATS provided over \$300,000 in donations to community-based organizations in fiscal 2021. We're proud to support these organizations and look forward to continuing to partner with our communities and having a positive impact on the lives we touch.

Key Performance Indicator	Metric	Fiscal 2021	Fiscal 2020	Fiscal 2019
Donations	\$ donated	+300,000	+250,000	+350,000
Communities impacted	% communities where we are located	15	9	—*
Number of activities engaged	# events	22	39	—*

* Data not tracked

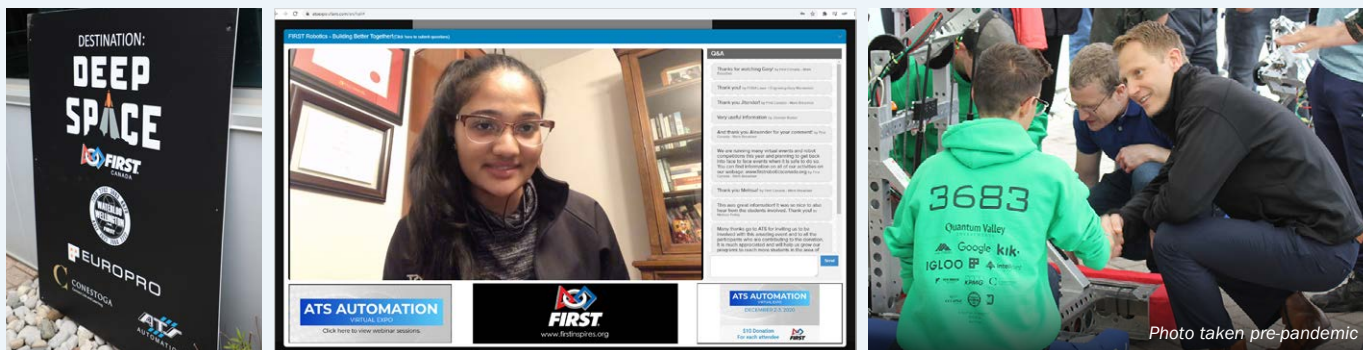

Virtual Expo Helps Put STEM FIRST

On December 2 and 3, 2020, ATS held its first virtual Expo. Over 1,500 registered attendees joined with professionals from 15 ATS segments and more than 40 of the Company's growth partners to discover and explore the latest developments in automation and smart technology. Attendance was free and participants from around the world were able share the insights of 10 automation industry thought leaders, visit virtual booths hosted by ATS and its partners, and also meet live with over 100 experts in the field.

"Companies around the world are searching for ways to create safer, more productive work environments and supply chains and it is automation and industry 4.0 technologies that will deliver the future of efficient, effective production that these organizations require," said Andrew Hider, ATS CEO.

As part of the event, ATS also donated \$15,000 – \$10 for every person who registered for the Expo – to its charity partner, FIRST® Canada. For more than three decades, FIRST® (For Inspiration and Recognition of Science and Technology) has inspired young people to become leaders and innovators in the areas of science and technology. ATS shares FIRST's vision, and we have sponsored their activities for several years. In addition to making a financial donation, ATS used the Expo to prominently feature educational content about FIRST® Robotics and their mission.

"Our industry benefits from educational systems that produce STEM graduates, and FIRST® is the reason that many children develop an early passion for the sciences," said Mr. Hider. ATS looks forward to strengthening its relationship with FIRST® and to encouraging more young people to pursue education and career opportunities in science, technology, engineering and math.

Helping to Address Food Insecurity



As part of our commitment to support the communities where we live and work, in 2021, we focused on addressing pandemic-driven food insecurity and were proud to support food banks around the world. Above, (left) our Life Sciences Chicago facility donated U.S. \$20,000 to the Greater Chicago Food Depository and (right) ATS Industrial Automation in Columbus, Ohio contributed U.S. \$20,000 to the Mid-Ohio Food Bank.



Safety Skills Save Lives

When an emergency struck, ATS employee Joe Costa was able to use skills he gained on the job to save a life.

A member of the Mechanical Assembly Team at our Cambridge Life Sciences facility, Joe is also a Life Sciences Cambridge Emergency First Responder. In 2021, Joe was able to put the health and safety training he received through St. John’s Ambulance at ATS Cambridge into action. When a neighbour experienced a life-threatening event, and every second counted, Joe was able to save that person’s life, drawing on his knowledge of First Aid and CPR.

“The knowledge and preparation in the St. John’s Ambulance courses can make a huge difference in someone’s life,” says Joe, “whether at work or at home. I encourage all employees to get involved in health and safety training, and take the time to learn First Aid and CPR. You never know when you’ll need it.”

Joe’s response and concern were extraordinary and serve as exceptional examples of what ATS can achieve through building a culture where people are empowered to ‘own’ health and safety.

Responsible Manufacturing and Service

ATS provides innovative solutions and services to leading companies in markets around the world.



ATS has a global presence, which means we also have a global environmental impact. To address that impact, we have made becoming carbon neutral by 2030 one of our cornerstone sustainability targets. Our ongoing efforts to achieve this target are embedded in our approach to responsible manufacturing and service. While offsets may play a role in hitting our carbon target, we are focused on evaluating our current operations and finding opportunities to decarbonize our activities. We have already made some headway and are steadily accelerating and building upon our achievements.

Our Board oversees our decarbonization efforts and our day-to-day actions are guided by our Global Health, Safety and Environmental Management System and the ATS HSE Policy. A powerful indicator of the overall success of our policies and actions is that across all of our global activities and operations, ATS had no reportable environmental incidents in fiscal 2021.

Our activities in environmental management align with SDG 12: Responsible Consumption and SDG 13: Climate Action (See “Alignment to the SDGs,” [page 13](#)). We measure our progress on environmental issues by gathering data on energy consumption, carbon emissions, water usage and waste production from across our operations. The insights gained from this data provide the foundation for improving our environmental performance.

We are committed to sustainability in our operations, design and manufacturing as well as in our sales and service. Sustainability includes ensuring that we can fulfill our obligations in an environmentally responsible fashion while also supporting our customers in achieving their sustainability goals by, for example, using automation solutions to reduce their energy impact or minimize waste.

One of the ways we reduce our energy footprint is by maximizing the value and reliability of our supply chains. While ATS sources parts and products from Asia, which helps us remain price competitive, we are focused on efficiency in transportation and ensuring that our vendors strictly comply with our Supplier Code of Conduct. To this end, we continue to develop our Global Supply Chain base. This allows us to access critical components from vendors located around the world while also working to establish a sustainable balance between the delivery times for these components and the carbon emissions associated with transportation.

In fiscal 2021, we made progress on formalizing a method for working with suppliers to achieve carbon reductions in our sourcing process. In addition, as part of our integration activities with recently acquired businesses, we have identified – and are moving forward on – further opportunities to develop and refine our approach with critical supply chain partners. As a result, we see new opportunities to strengthen our supply chain while reducing associated carbon emissions; ATS is working toward this goal. We look forward to introducing this methodology in fiscal 2022.

We train ATS Global Services teams to seek out waste within our customers’ operations and reduce, improve and eliminate the conditions that contribute to lost opportunity, profitability and overall loss. In doing so, we create opportunities for our customers to reduce scrap and material waste in their production cycles, decrease energy consumption and, where possible, increase productivity rates so that customers can operate profitably over fewer shifts.

Targets 2030

Responsible Manufacturing and Service	Target 2030	Fiscal 2021	Fiscal 2020
Scope 1 and 2 emissions from operations in TCO ₂ e	Carbon neutral	32,165.17	36,202.59

Supporting Green Transportation

Our Industrial Automation business is partnering with our automotive OEM customers to support the growth of the green transportation industry. With our deep experience in battery lines, we can create solutions for high-speed cell handling and cell-to-end-of-line test solutions. At the same time, we are reducing floor space requirements by integrating best-in-class machine components such as our SuperTrak™ linear motion technology solution.

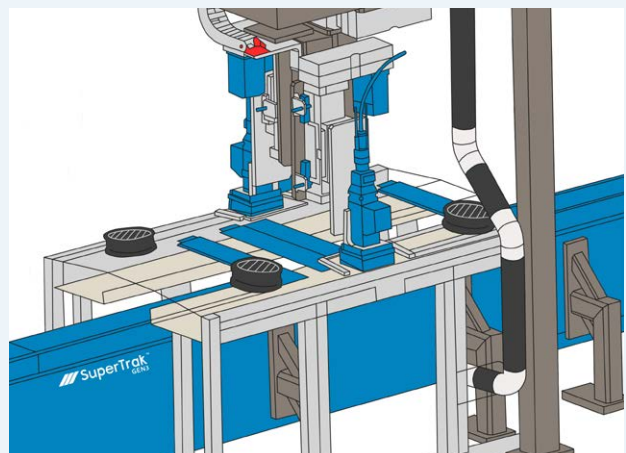

Working Smarter for Our Customers

Our Illuminate™ manufacturing intelligence software creates a fully remote connected presence with our customers, through which we can monitor, diagnose and initiate corrective actions on behalf of our customers, without the lead times or carbon footprint associated with traditional dispatched, in-person service responses. Our Enhanced Remote Support offering connects ATS customers directly to subject matter experts (SMEs). Further reducing lead times for resolving customer challenges means reducing the carbon footprint associated with dispatching personnel. ATS' Smart Coach training solutions are designed to coach a customer's workforce on site, as needed. Expertly created content provides training to customer teams without requiring travel or additional resources. In turn, this enhances the speed of training delivery, eliminates travel time and reduces our carbon footprint.

ATS has a proven track record for upgrading and enhancing our customers' systems, avoiding the pitfalls of obsolescence and extending asset life. Modifying customers' existing assets can lower total cost of ownership and reduce time to market for new products compared to commissioning an entirely new system. ATS is proud to prevent premature decommissioning and equipment waste on behalf of our customers; equipment is built to last, and we're committed to maintaining customer production lines' reliability and lifespan.

Energy and Emissions

Energy consumption is one of the most significant environmental impacts generated by ATS. Consequently, over the last few years, we've worked to find new solutions and best practices to improve the energy performance of our buildings. We strive to align our energy- and emissions-related strategies and activities with SDG 12 and 13. In fiscal 2021, we incorporated energy-efficient solutions into two building construction and renovation projects in Columbus, Ohio and Cambridge, Ontario. We made progress in converting to LED lighting across our facilities through fiscal 2021 and expect this work to continue into fiscal 2022. In addition, where feasible, we are installing photovoltaic rooftop systems to take advantage of renewable solar energy. We also pursued supporting more sustainable transportation options for our employees, which includes increasing the availability of e-vehicle charging stations at our facilities.

Across our operations, we are constantly looking for ways to reduce our energy and emissions footprint. At our Comecer facility in Bologna, Italy, we moved to 100% renewable energy purchased only through Guarantee of Origin (GO) certified sources. A Kaizen held by the team at sortimat Handling Systems in St. Georgen, Germany identified ways to reduce energy usage, including improved lighting, moving to LED, decreased energy waste and an enhanced working environment.

In fiscal 2022, we will inaugurate a new energy-efficient facility in Ohio to support our Industrial Automation customers. Every new and upgraded facility provides us with experience and information that will support our long-term efforts to become carbon neutral.





ATS Life Sciences, Cambridge, Ontario

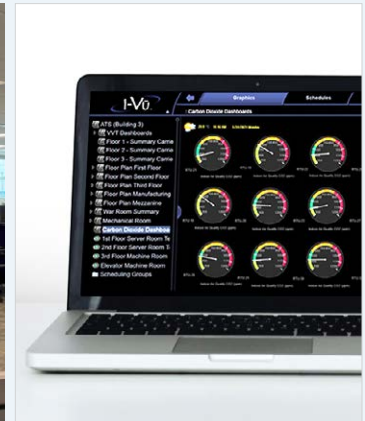
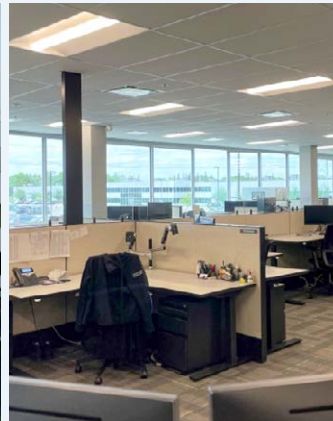

ATS Industrial Automation, Columbus, Ohio



sortimat Handling Systems, St. Georgen, Germany

Expanding Our Energy-Efficient Infrastructure

Over the course of fiscal 2021, three forward-thinking infrastructure projects in three countries showed the kind of steps we're taking to meet our commitments to energy efficiency and to hitting our target of becoming carbon neutral by 2030. In Cambridge, Ontario, at our headquarters campus, we were proud to unveil the expansion to the ATS Life Sciences Building. The upgraded facility incorporates strategies and technologies that will deliver year over year cost savings while significantly reducing energy consumption. New energy-efficient features include upgraded windows that provide extensive natural light, supplemented by LED lighting, and a remote control, high-efficiency HVAC system for improved management of ventilation and temperature. The new system supports area-specific temperature control zones along with CO₂ monitoring for indoor air quality and automates preventive maintenance task scheduling such as filter changes. Airflow within the facility played a crucial role in keeping onsite employees safe while maintaining business operations during the

pandemic. By adjusting the HVAC system, the volume of ventilation was increased by 202%.

In Columbus, Ohio, work began on a new 200,000 square foot Industrial Automation facility, which will open in fiscal 2022. Energy conservation was a key consideration in the new facility's design, which incorporates programmable, sensor-linked LED lighting and low-emissivity windows throughout; shade screening on the west side that helps maintain a constant temperature; a high-efficiency HVAC system; two sets of doors at all entryways; and three EV charging stations, with rough-ins for future expansion.

Using the ABM approach to problem solving, staff at sortimat Handling Systems in St. Georgen, Germany held a Kaizen to identify ways for decreasing annual energy and operational costs, while also reducing waste and improving workplace ergonomics. The team identified improved lighting as an opportunity for cutting costs and energy usage while enhancing the work environment. Tailored lighting solutions were developed for each specific location within the facility, with a projected payback period of less than three years.

Electrical Consumption and Energy Mix

In 2021, our overall electricity consumption was influenced by a combination of factors. Our investments in energy-efficient lighting and HVAC systems had an impact. Due to the pandemic, across our operations we had fewer employees on site, which moderated our electricity usage.

Key Performance Indicator	Metric	Fiscal 2021	Fiscal 2020	Fiscal 2019
Electricity consumption	MWh consumed (absolute)	18,393.80	18,275.91	17,206.40

Energy Mix

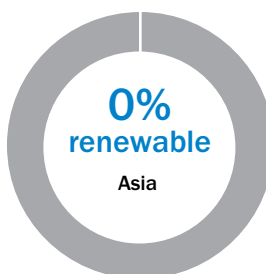
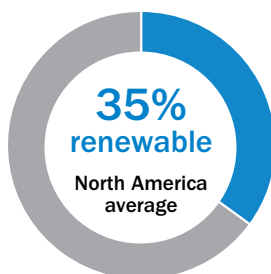
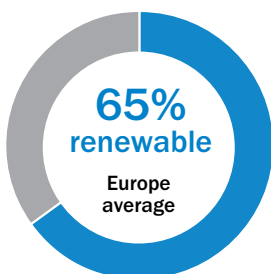

Our Approach to Climate Change

ATS recognizes the long-term challenge posed by climate change and our obligation to contribute to a solution. In past years, we have participated in the Carbon Disclosure Project (CDP), tracking emissions across our operations and publicly disclosing the findings on the CDP website. This year, we continue to publish results that align with the CDP questionnaire.

Additionally, our approach to climate change features a range of governance and management practices, including a response to climate risk that incorporates strategic questions about the prioritization and cost implications of climate-related initiatives. We are also benchmarking against peers in the industrial manufacturing and automation sector to establish best-in-class metrics.

Note: The acquisition of the CFT Group of Companies was completed at the end of fiscal 2021, so their data is not included in this report. We will incorporate their data into the fiscal 2022 sustainability report.

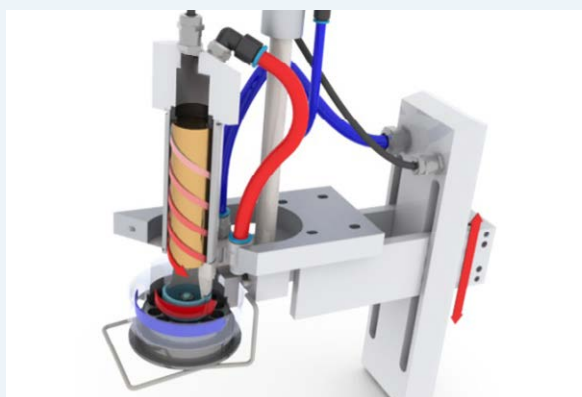

Innovation and Energy Efficiency in Manufacturing at IWK Germany

IWK develops leading-edge technology for tube filling and cartoning automation in the pharmaceutical, cosmetics and food markets. A recently introduced tube filling solution demonstrates IWK's commitment to innovation and responsible manufacturing: incorporating a heat exchanger into the heating cartridge of the hot-air tube sealing application delivered a 10% reduction in electrical energy use, with the increased energy conservation savings going directly to our customers.

Emissions, Fiscal 2021

	Fiscal 2021	Fiscal 2020	Base Year 2010
Scope 1 emissions (metric tons CO ₂ e)	5,122.77	6,223.93	10,439.78
Scope 2 emissions (metric tons CO ₂ e)	27,042.40	29,978.66	6,814.14
Scope 3 emissions (metric tons CO ₂ e)			
Employee commuting ¹	10,042.35	33,616.63	24,364.45
Business travel	1,959.06	7,302.45	6,743.41
Scope 1 and 2 intensity figure (tons CO ₂ e) – Revenue	0.000022	0.000025	0.000027
Scope 1 and 2 intensity figure (tons CO ₂ e) – FTE	6.43	8.23	7.73
Natural gas (MWh)	17,439.57	22,921.00	Not calculated
Heating oil (MWh)	531.91	1,351.49	Not calculated
Consumption of purchased or acquired electricity (MWh)	18,393.80	18,275.91	20,331.00
Scope 1 emissions by greenhouse gas type			
CO ₂	3,389.34	1,600.63	2,720.00
CH ₄	5.93	7.13	4.68
N ₂ O	1.99	2.67	1.45
HFCs	6.80	3.06	7,713.00

¹ Significant decreases in employee commuting and travel due to impact of pandemic controls

Emissions Breakdown by Country, Fiscal 2021

Country	Scope 1	Scope 2
North America		
Canada	1,147.00	1,518.93
USA	435.38	22,537.80
Asia		
China	1.16	185.25
Singapore	0.00	6.43
Thailand	99.63	423.52

Country	Scope 1	Scope 2
Europe		
Austria	62.15	6.55
Belgium	344.23	11.05
Czech Republic	147.59	54.23
England	0.00	41.77
Germany	2,132.89	1,678.24
Ireland	2.18	0.28
Italy	565.55	520.36
Netherlands	80.44	47.96
Poland	Operations discontinued	Operations discontinued
Slovakia	91.16	9.75
Sweden	8.66	0.12
Switzerland	4.74	0.16

Water Usage

ATS' operations and facilities do not consume significant amounts of water. For the most part, water consumption at our facilities is tied to hygiene, kitchen and irrigation uses. All greywater generated at our facilities goes to municipal facilities where it is treated to meet local standards.

In fiscal 2021 our usage was impacted by the number of employees who worked remotely for much of the year as result of the pandemic.

Water Usage by Geography (m³)

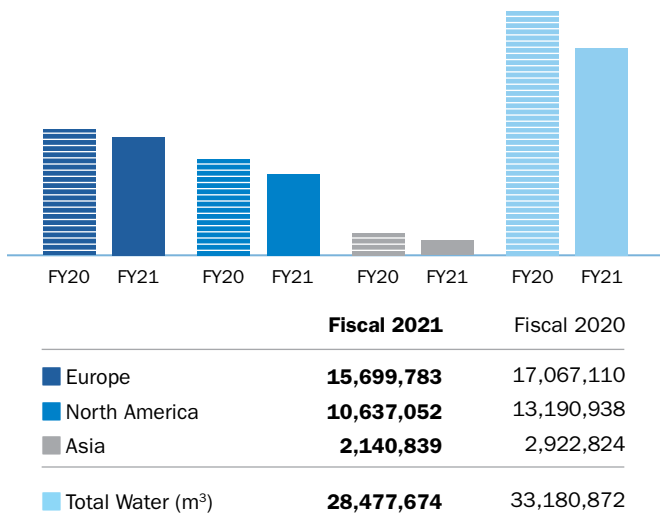

Waste Management

ATS designs custom solutions to meet customer needs. For the most part, we deliver those solutions by assembling components and equipment produced elsewhere. So, while our operations do not generate much waste in themselves, there is a significant amount of packaging waste associated with our activities. In fact, packaging is the largest portion of our waste stream. As a result, the principal focus of our waste management efforts continues to be diverting and reducing our generation of non-hazardous waste.

Our most recent internal organization-wide waste audits show that our waste diversion rate from landfill or incineration is 83.6%, exceeding the 80% target we set for fiscal 2020. Unfortunately, due to the pandemic, we did not conduct third-party waste audits in fiscal 2021, and we look forward to resuming such audits as reopening activities permit. Additionally, we continue to apply our Build Safety Risk Assessment process to evaluate the potential environmental impacts of projects, in order to predict and plan for waste reduction and the safe, sustainable disposal of waste materials.

While our generation of hazardous waste is minimal, we still audit our facilities to ensure that all waste generator registrations are up-to-date and that we only use properly certified waste haulers and waste disposal sites. In fiscal 2021, we implemented a global tracking of hazardous waste streams and quantities to look for further opportunities as a company to further minimize our generation of hazardous waste.

Waste Diversion Rate from Landfill/Incineration

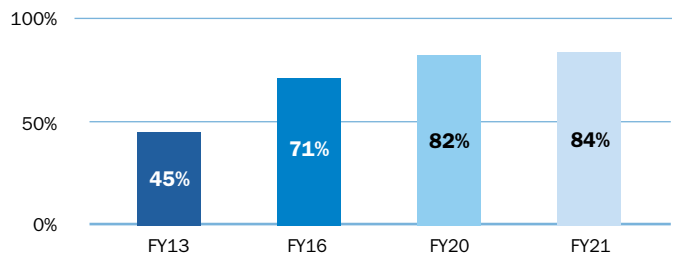

Composting Organic Waste at Our Cambridge Campus

At our headquarters and campus in Cambridge, Ontario, ATS launched an organic composting initiative across

our cafeteria facilities. Food waste, paper plates and compostable utensils made from corn fibres are collected on site and then diverted to a local composting partner. Through the program, we can divert up 6,000 tons of compostable waste annually.



Looking Ahead

At ATS, we are proud of the efforts of our people around the world, and the outstanding resilience they have shown. They enabled us to navigate a challenging environment and continue to build a great company.

We firmly believe that automation and technology matched with commitment and innovation can offer solutions for some of the world's most challenging problems.

The 2030 sustainability targets we've set for our Company reflect this belief. These targets challenge and energize us.

We will continue to empower our employees to deliver substantive change, drawing upon their skills and imagination and applying the ABM to drive continuous improvement in our solutions and sustainability performance.

“Looking to the future, our commitment to ESG will position us well to grow and succeed by achieving our purpose: Creating solutions that positively impact lives around the world.”

Andrew Hider, CEO



SASB Index – Industrial Machinery & Goods Standard

Topic	Accounting Metric	Code	Fiscal 2021	Comments
Energy Management	Total energy consumed	RT-IG-130a.1	18,394 MWh 66,218 GJ	
	Percentage grid electricity		Europe – 35% North America – 65% Asia – 100%	
	Percentage renewable		Europe – 65% North America – 35% Asia – 0%	
Employee Health & Safety	Total recordable incident rate (TRIR)	RT-IG-320a.1	0.87	Calculated as (statistic count x 200,000)/hours worked
	Fatality rate		0.00	Calculated as (statistic count x 200,000)/hours worked
	Near miss frequency rate		0.85	Calculated as (statistic count x 200,000)/hours worked
Fuel Economy & Emissions in Use-phase	Sales-weighted fleet fuel efficiency for medium- and heavy-duty vehicles	RT-IG-410a.1	Not applicable	ATS does not manufacture or sell vehicles, off-road vehicles or diesel engines which are powered by fossil fuels.
	Sales-weighted fuel efficiency for non-road equipment	RT-IG-410a.2	Not applicable	
	Sales-weighted fuel efficiency for stationary generators	RT-IG-410a.3	Not applicable	
	Sales-weighted emissions of: (1) nitrogen oxides (NO ₂) and (2) particulate matter (PM) for: (a) marine diesel engines, (b) locomotive diesel engines, (c) on-road medium- and heavy-duty engines, and (d) other non-road diesel engines	RT-IG-410a.4	Not applicable	

Topic	Accounting Metric	Code	Fiscal 2021	Comments
Materials Sourcing	Description of the management of risks associated with the use of critical materials	RT-IG-440a.1	See page 19	
Remanufacturing Design & Services	Revenue from remanufactured products and remanufacturing services	RT-IG-440b.1	\$80 million	
Activity Metrics				
Number of units produced by product category		RT-IG-000.A	ATS deployed 500 systems (contracts valued over \$250,000)	
Number of employees		RT-IG-000.B	>5,000	

Forward-Looking Statements

The intention of the ATS Automation Tooling Systems Inc. (“ATS”) Sustainability Report is to communicate the company’s strategy and performance related to sustainable development with reference to performance metrics across four areas of key importance: Ethics and Integrity, Our People, Social Responsibility, and Responsible Manufacturing and Service. The report relates to our fiscal year 2021, from April 1, 2020 to March 31, 2021. We anticipate our next Sustainability Report to be released after the close of our fiscal year 2022.

This document may contain certain statements that constitute forward-looking information within the meaning of applicable securities laws (“forward-looking statements”). Such forward-looking statements involve known and unknown risks, uncertainties and other factors that may cause the actual results, performance or achievements of ATS, or developments in ATS’ business or in its industry, to differ materially from the anticipated results, performance, achievements or developments expressed or implied by such forward-looking statements. Forward-looking statements include all disclosure regarding possible events, conditions or results of operations that is based on assumptions about future economic conditions and courses of action. Forward-looking statements may also include, without limitation, any statement relating to future events, conditions or circumstances. ATS cautions you not to place undue reliance upon any such forward-looking statements, which speak only as of the date they are made. Forward-looking statements relate to, among other things, five long-term sustainability targets. The risks and uncertainties that may affect forward-looking statements include, among others, general market and economic performance, performance of the Canadian dollar, performance of the market sectors that ATS serves, that ATS may not meet one or more of the long-term sustainability targets for any number of reasons including failure of workplace safety programs to generate the desired results, inability to attract female leadership talent, lack of employee engagement in social responsibility initiatives, unexpected costs associated with reducing emissions and inability to source energy from providers that support lower emissions, and other risks and uncertainties detailed from time to time in ATS’ filings with Canadian provincial securities regulators. Forward-looking statements are based on management’s current plans, estimates, projections, beliefs and opinions, and ATS does not undertake any obligation to update forward-looking statements should assumptions related to these plans, estimates, projections, beliefs and opinions change.

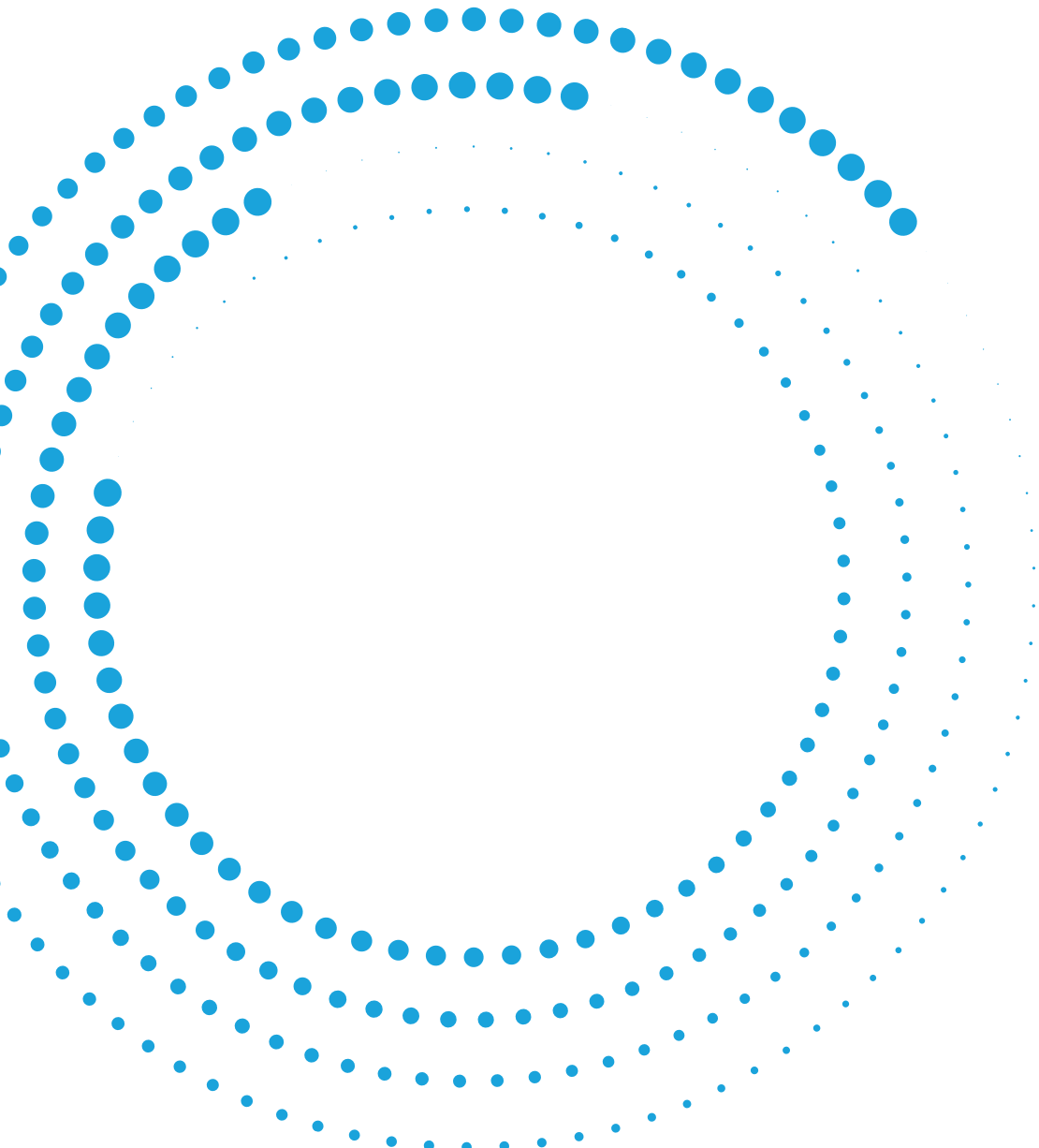

ATS Automation

ATS Automation Tooling Systems Inc.
730 Fountain Street North
Cambridge, Ontario, Canada N3H 4R7

ATSAutomation.com

Concept and Design: THE WORKS DESIGN COMMUNICATIONS
worksdesign.com